

www.AKCP.com

Tank Depth Pressure Sensor Manual



Copyright © 2020, AKCP



Table of Contents

| | |
|---|-----------|
| Introduction | 3 |
| Compatibility | 3 |
| Sensor variants | 4 |
| Sensor measurement resolution & accuracy..... | 4 |
| Installation mounting procedure max run length & wiring diagram..... | 5 |
| Web UI configuration | 7 |
| Specifications | 13 |
| Technical drawing..... | 15 |

Introduction

Tank Depth Pressure Sensors are ideal for monitoring fuel or water storage tanks. Lower the sensor into the tank until it reaches the bottom, and it will sense the pressure exerted by the water column above. Based on the pressure and the type of liquid you are measuring above the sensor, the depth is calculated. By programming the base unit with your tank dimensions, the total volume in % or litres can be displayed.

The sensor must be connected directly to the AKCP base units in order to function. It is easily configured in the base units web user interface which will be covered later in this manual.



Compatibility

This sensor is compatible with all sensorProbe+ (SP2+ & SPX+) base units only. It is not compatible with sensorProbe units.

Currently this sensor is not supported on the securityProbe family of base units, however this may be added in the future with later firmware. Please check with our support team on this.

Sensor variants

TDPS are available calibrated for different tank depths from 2 to 20 meters.

The product code is TDPS-xx where the xx is the depth that the sensor is calibrated for. We are providing 5 depths:

TDPS-2 (Tank Depth Pressure Sensor for 2 meter tank)*

TDPS-5 (Tank Depth Pressure Sensor for 5 meter tank)*

TDPS-10 (Tank Depth Pressure Sensor for 10 meter tank)*

TDPS-15 (Tank Depth Pressure Sensor for 15 meter tank)*

TDPS-20 (Tank Depth Pressure Sensor for 20 meter tank)*

You can select the sensor that matches the maximum liquid/tank depth.

TDPS has the advantage that it can be used on tanks up to 20 meters deep compared to the 2 meter limit on the UFLS-NI.

**Please refer to technical specifications as maximum liquid depth depends on the liquid type being measured.*

Sensor measurement resolution

- 2 meter version: in 1% steps
- 5, 10, 15, 20 meter versions: in 0.1% steps because due to the size of the tank, a 1% difference is huge in a big tank

Note that these values are measured for clear water with 4°C temperature. Different kinds and temperatures of liquids would alter the measurement slightly.

Sensor Accuracy

The fuel sensor accuracy is 1% of the full scale. This is the case with most sensors, accuracy is on full scale.

That means you have a 1% accuracy based on 2meters with the smallest TDPS. This would equate to +/- 200mm on a 2 meter tank. That would mean 9mm on a 90cm tank (1% of 900mm).

The tank level sensor is not meant to be a precision instrument. It is designed for monitoring the tank level as an indication of when the tank needs refilling. It is not meant to give accurate readings of the fuel usage based on monthly tank level changes.

Installation and mounting procedure

This sensor will be hanging in the tank. You need to measure the tank depth, mark that on the cable and then lower it into the tank as far as the marker. The sensor shouldn't touch the bottom of the tank, it should hang just a centimeter or so above. Follow the procedure below.

- 1) Measure the height of the tank.
- 2) Mark the height of the tank on the sensor cable.

Mark cable with the depth of the tank, measure from the tip of the sensor.



- 3) Drill a hole in the tank with 30mm diameter for the sensor to drop in through, drill out 4 mounting bolt holes 5mm in diameter and thread the holes.

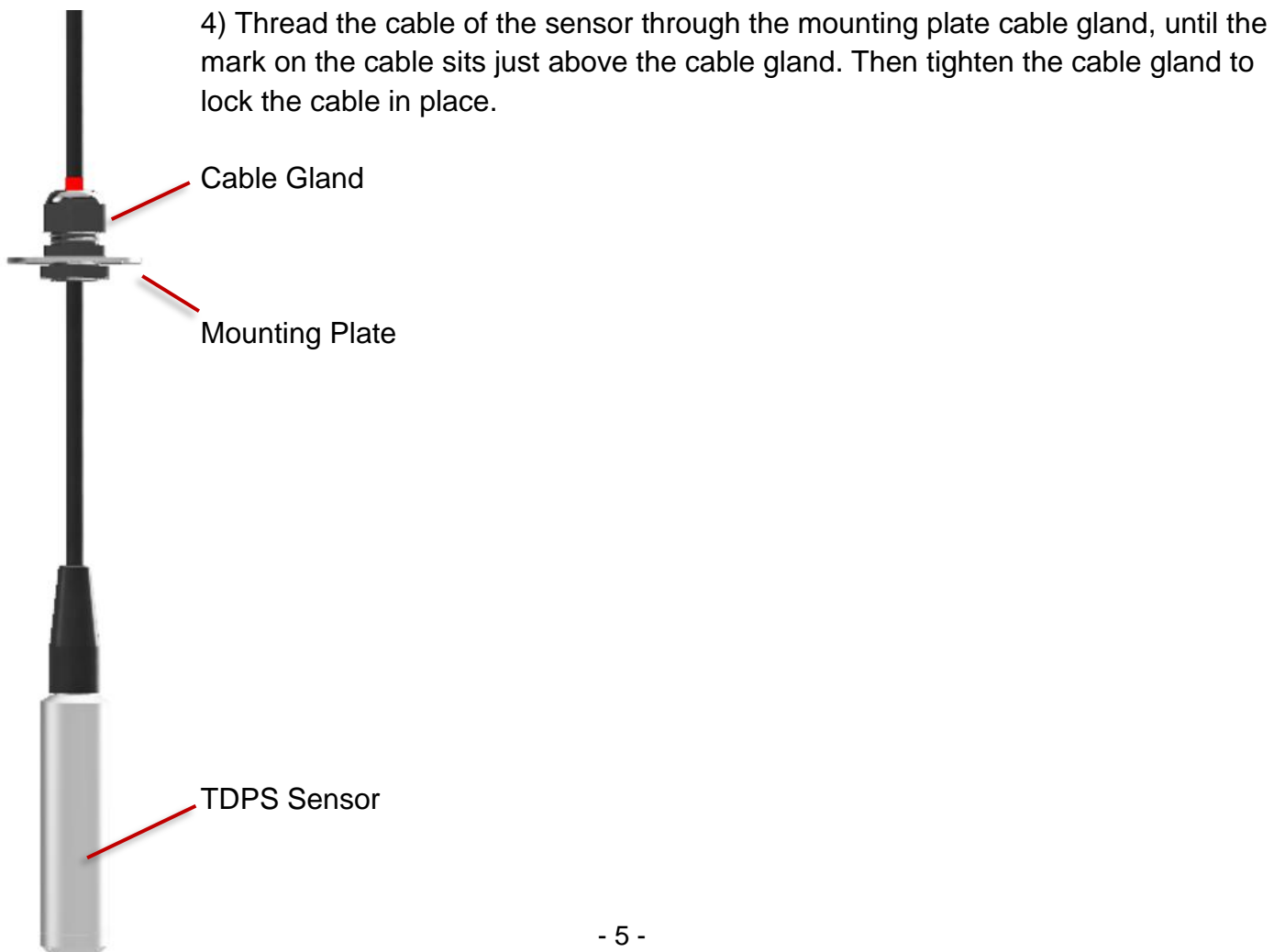

- 5) Drop the sensor through the hole in the tank, and check that the mounting plate is completely in level with the tank surface. Ensure that the sensor is not touching the bottom of the tank (if measured correctly, the sensor should be sitting now about 3cm above the bottom of the tank).
- 6) Secure the mounting plate to the tank with 4x M5 bolts, and seal the edges of the mounting plate with silicone sealant.

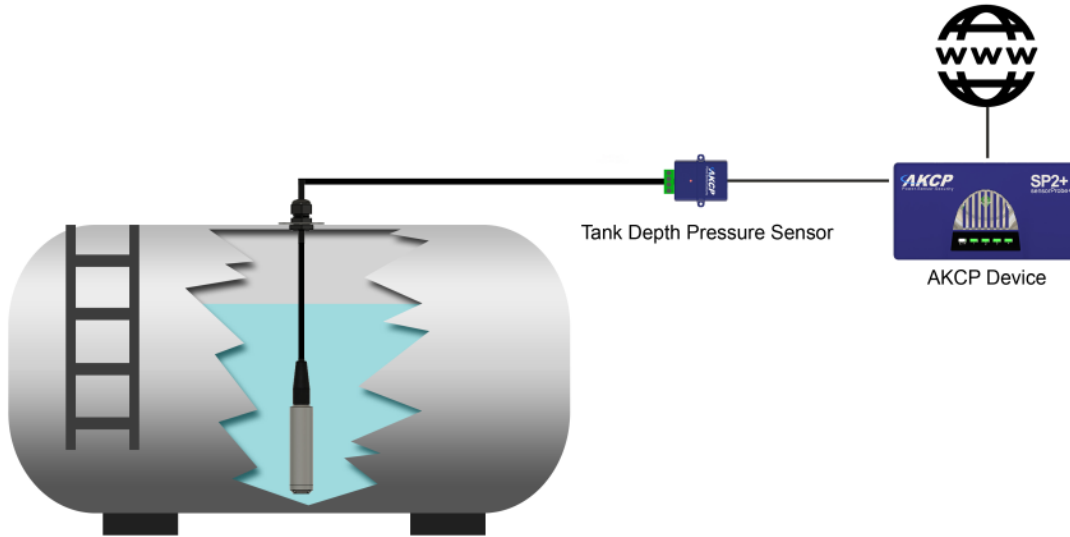

- 7) Connect the TDPS to the base unit's sensor port via the converter box and RJ45 cable.
- 8) No external power supply required. The TDPS is powered via the converter box.

Maximum Cable Extension Length

The maximum run lengths of the RJ-45 LAN cable from SP+ to the sensor module is 10 meters, or up to 15 meters with high quality CAT5 cable. If you need a longer range you can check on upgrading to our LoRa based TDPS sensor. The cable from the module to the TDPS cannot be extended.

Wiring Diagram on the SPX+ & SP2+

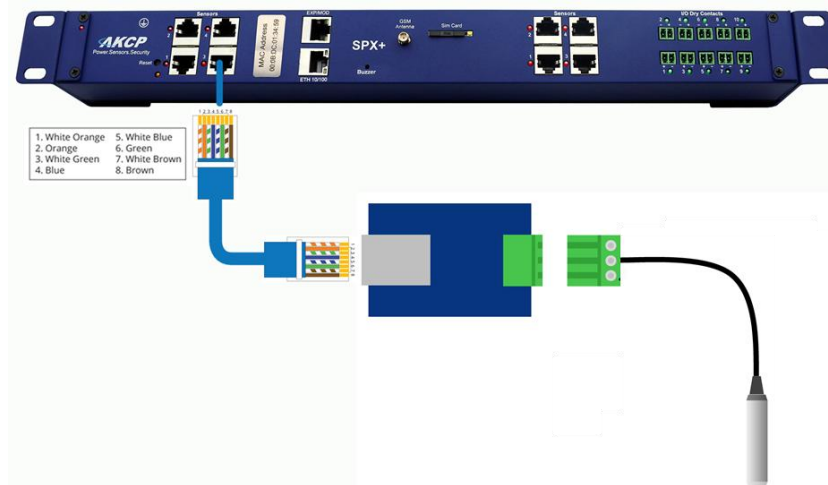

Web UI configuration

sensorProbe+ and base units

To begin make sure you have connected your TDPS sensor to the base unit via the RJ45 connection, then navigate to the web interface of your module. This is shown below:-

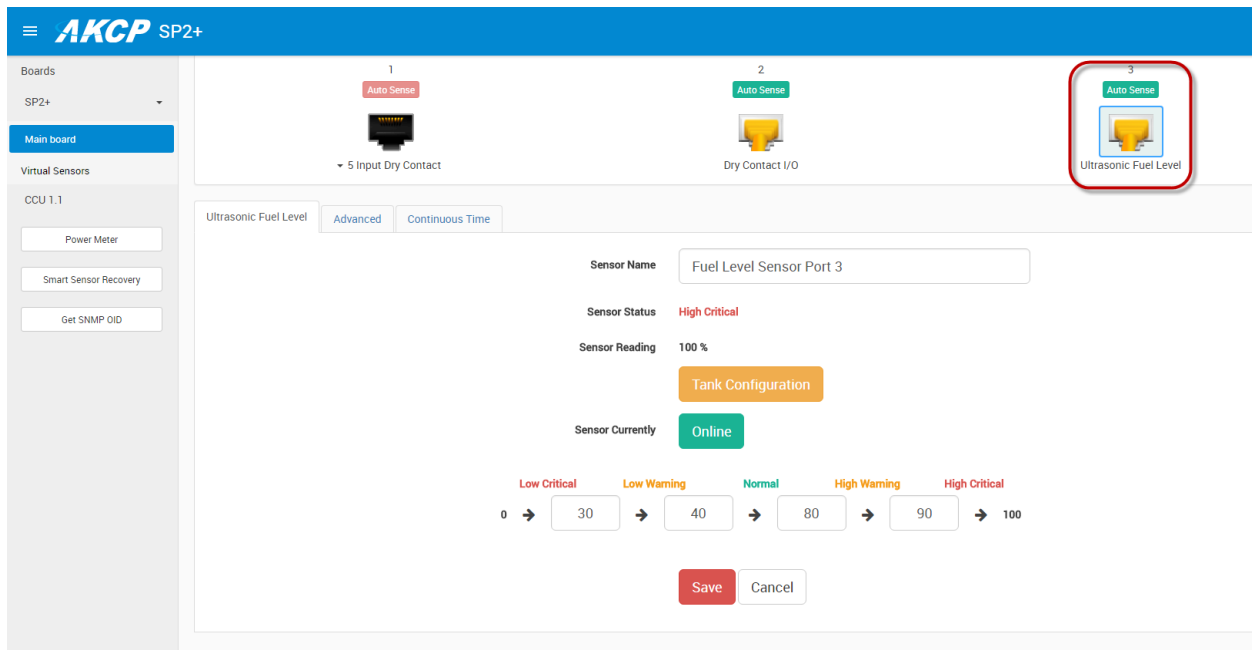
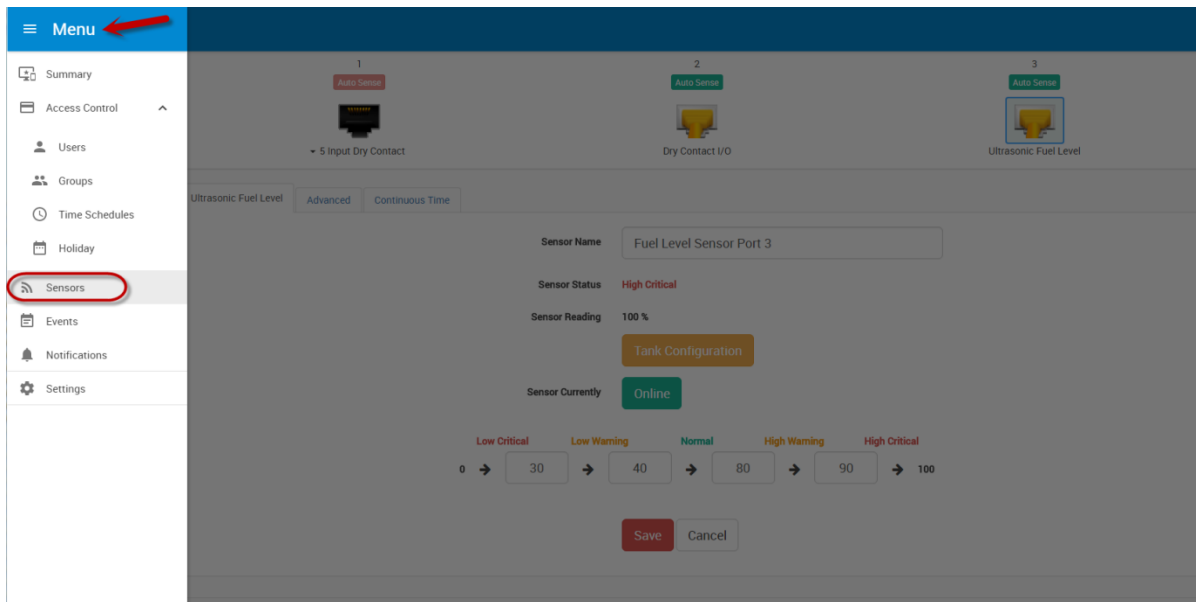

In the page shown above you can set your tanks alert threshold percentages.

On this page the Tank Configuration setup will be explained.

It is very important to set your tanks correct configuration, either Linear or Non-Linear, or the sensor will not detect the fuel level properly.

Click on the **Tank Configuration** button to begin:

Tank Configuration ✕

Sensor Type

Tank Level Increasing Linear Non-Linear

Unit Metric US.

Fluid Type

Max Liquid Height Meters

In the firmware we support earlier types of UFLS sensors in addition to the TDPS. Therefore you'll be required to choose the correct type of the sensor in the **Sensor Type** drop-down list:

Sensor Type

Level Increasing

- None
- Invasive
- Non-Invasive
- Depth Pressure**

Depth Pressure is required for TDPS.

Depending on the sensor type, different configuration options will be shown.

We'll only focus on the TDPS in this manual.

Tank Level Increasing

Linear
 Non-Linear

Next choose the type of your tank. If the level of liquid is always Linear, it's the simplest configuration. Choose between Metric or Imperial measurement units.

Fluid Type Water ▼

Top Limit

Fluid Height

Water
 Petrol
 Diesel
 Chemical Waste

Choose the correct fluid type that is in the tank. Different kind of fluids will have different measurement allowances that you can specify at **Max Liquid Height**.

Tank Configuration ✕

Sensor Type Depth Pressure ▼

Tank Level Increasing

Linear
 Non-Linear

Unit

Metric US.

Fluid Type Water ▼

Diagram illustrating a non-linear tank geometry. A cylinder is shown at an angle. The radius is labeled 'R' and the length is labeled 'X'.

« Non-linear Tank 1 »

Top Limit 0.02 Meters

X 0 Meters

R 0 Meters

Save
Cancel

If you choose the **Non-Linear** tank type, an example schematics will be shown to help you set up the correct measurement.

You can use the >> button to scroll for more pre-defined tank types. These will all have different angle setups depending on the geometry of the tank.

This configuration wizard is similar to the UFLS on securityProbe units.

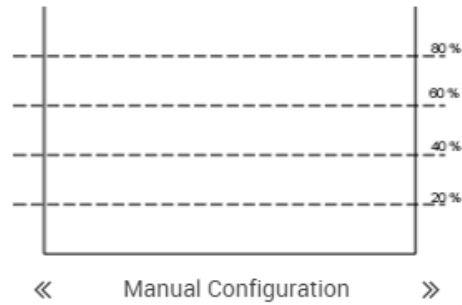

| | | |
|---------------|-----------------------------------|--------|
| Top Limit | <input type="text" value="0.02"/> | Meters |
| Tank Height | <input type="text" value="0"/> | Meters |
| Volume at 20% | <input type="text" value="20"/> | Litres |
| Volume at 40% | <input type="text" value="40"/> | Litres |
| Volume at 60% | <input type="text" value="60"/> | Litres |
| Volume at 80% | <input type="text" value="80"/> | Litres |
| Full Volume | <input type="text" value="0"/> | Litres |

In case you couldn't find a suitable tank geometry, you can specify your own limits with the **Manual Configuration** option.

Sensor measurement resolution

- 2 meter version: in 1% steps
- 5, 10, 15, 20 meter versions: in 0.1% steps because due to the size of the tank, a 1% difference is huge in a big tank

Note that these values are measured for clear water with 4°C temperature. Different kinds and temperatures of liquids would alter the measurement slightly.

Next will be the advanced settings for the sensor.

| | |
|----------------------|---|
| Unit | % |
| Rearm | 5 |
| Data Collection Type | Instantaneous |
| Value at Max Level | 100 |
| Value at Base Level | 0 |
| Enable Calendar | <input type="radio"/> On <input checked="" type="radio"/> Off |
| Graph Enable | <input type="radio"/> Enable <input checked="" type="radio"/> Disable |
| Filter Status | <input type="radio"/> Enable <input checked="" type="radio"/> Disable |

Save Cancel

On the "**Advanced Settings**" tab the sensor actually displays by default the value in % of liquid in the tank. The **Max** and **Base** levels can be used to translate the % into quantity where the Base level is the quantity when the sensor reads 0% and Max level is the quantity when the sensor reads 100%.

Changing to Liters

You can change the display from a percentage to Liters by simply typing in Liters in the field shown below in the advanced settings. Don't select this from from the drop down list, just type in Liters, and then enter the maximum and minimum number of liters.

| | |
|----------------------|---------------|
| Unit | % |
| Rearm | 5 |
| Data Collection Type | Instantaneous |
| Value at Max Level | 100 |

°C
°F
%
%rh
V
mA

Please see below for the **Continuous Time** feature settings.

The continuous time settings window allows you to adjust the time for a sensor to be in a new status before the system accepts the new status.

This will help to eliminate false warnings in an unstable environment.

Ultrasonic Fuel Level Advanced Continuous Time

Continuous Time for a Sensor Status to be active before accepting as a new status ?

| | |
|---------------|--------------------------------|
| High Critical | <input type="text" value="0"/> |
| High Warning | <input type="text" value="0"/> |
| Normal | <input type="text" value="0"/> |
| Low Warning | <input type="text" value="0"/> |
| Low Critical | <input type="text" value="0"/> |
| Sensor Error | <input type="text" value="0"/> |

Save Cancel

You can set the amount of time to delay a notification of a status change from high warning to high critical. Enter the time in seconds and press the “Save” button. The amount of time that can be entered is between 0 and 65535 seconds which equals approximately 18 hours.

Specifications

| | |
|---|--|
| Tank size up to 20 meters | This sensor is calibrated for specific tank sizes, please select for either max 5, 10, 15 or 20 meter tank depth when ordering |
| Accurate measurement for non-linear size tank for static liquid level, via linearization | |
| Measurements | |
| Measurement Method | Hydrolic Pressure (Fluid column pressure) |
| Tank Depth | 0-20 m (65ft) for Water, 0-15m for Petrol, 0-16, 6 m for Diesel |
| Accuracy Distance | 0-2000 cm (65 ft) with 0.2% accuracy for water |
| Full Scale Accuracy | +/-0.5% FS (Max) |
| Mounting | Suspended inside the tank by leader cable |
| Cables | |
| Communications Cable | RJ45 jack to UFLS converter box using UTP Cat 5 wire |
| Communications Cable Max. length: | 30 meters (100 ft) |
| | Ships with a 15 foot CAT6 LAN extension cable |
| | CAT6 LAN extension cable be extended up to 30 meters (100 ft) |



| | |
|------------------------------------|--|
| Sensor Part Cable | Leader cable from the sensor part to the converter box is 5/10/15/20 meters respectively based on depth type ordered. |
| Environmental | |
| Chemical Resistance | Petrol, Diesel, Water |
| Operating Temperature Range | -20°C to 80°C |
| Protection Grade | IP68 (pressure sensor part) |
| Electrical | |
| | The module operates at 5V from sensorProbe+, securityProbe+ or E-Sensor8 |
| | The sensor part does not require an external power source |
| Notes | |
| | Works with certain types of fuel and fresh water. Select the correct type when configuring the sensor. |
| | Not supported on sensorProbe and securityProbe units. Requires sensorProbe+, E-Sensor8 expansion module or securityProbe+ |
| | Comes fully assembled, only needs calibration and installation. |

Technical drawing

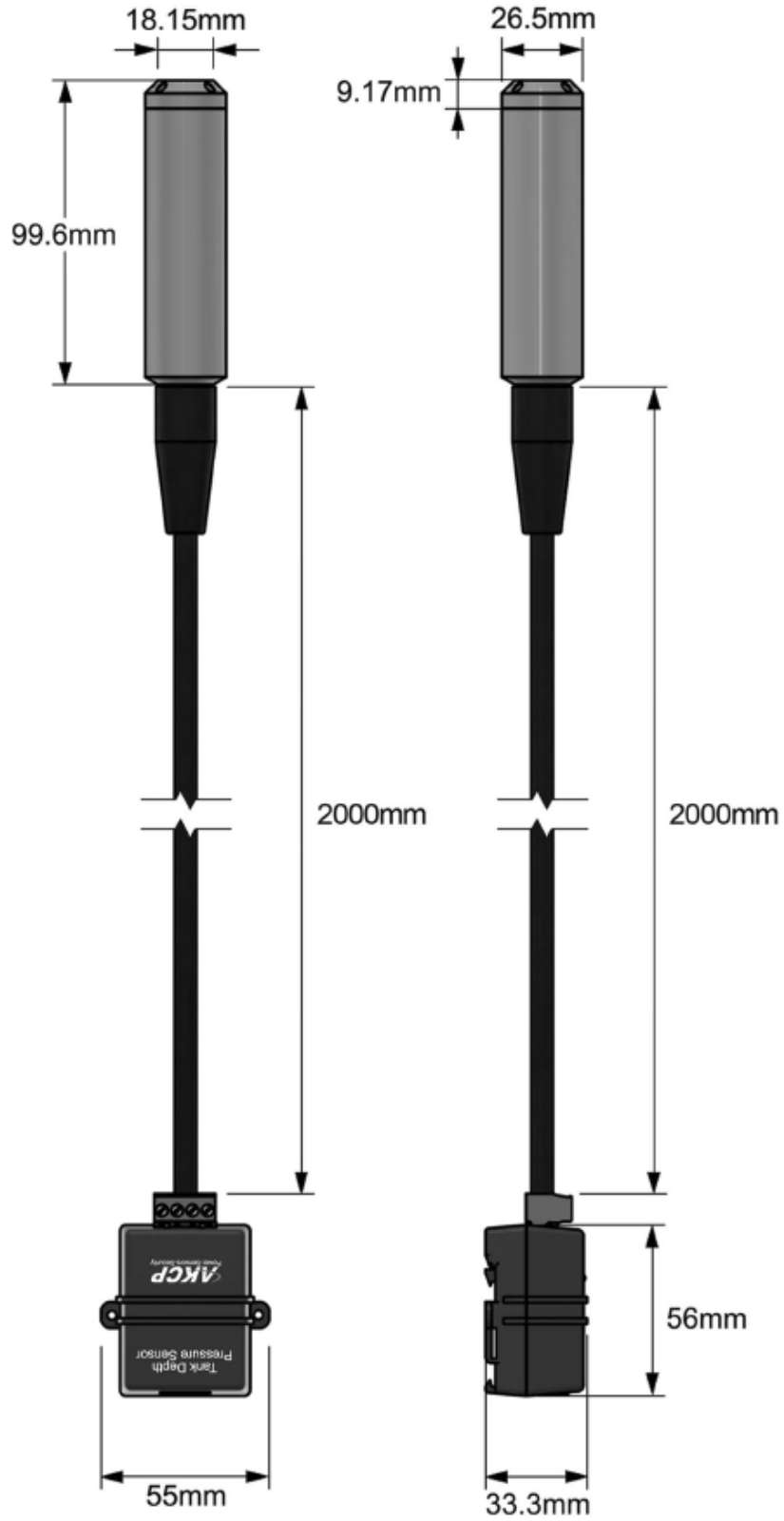



Please contact support@akcp.com if you have any further technical questions or problems.

Thanks for Choosing AKCP!